

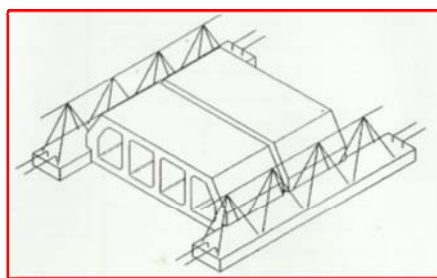

**DOPESA**

FABRICA DE MATERIALES DE CONSTRUCCION



**2017**  
**LISTA DE PRECIOS**

Vigentes desde el 11/01/2008



SEMIVIGUETAS	
Canto 12-17-20-22-25-30	
	e/ml
Hasta 3,00.....	6,49
" 3,30.....	6,63
" 3,60.....	6,75
" 3,90.....	6,95
" 4,20.....	7,40
" 4,50.....	7,68
" 4,80.....	7,88
" 5,10.....	7,96
" 5,40.....	8,13
" 5,70.....	8,66
" 6,00.....	9,01
" 6,30.....	9,22
" 6,60.....	9,39

**No Disponible**

VIGAS MACIZAS	
Canto 18	
	e/ml
Metro lineal.....	11,91

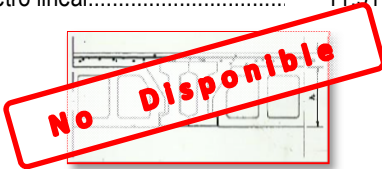

BOVEDILLAS	
	e/Ud
* De 10,00 x 12,50 x 62.....	1,18
De 10,50 x 25,00 x 62.....	1,25
De 17,00 x 20,00 x 62.....	1,30
* De 18,00 x 15,00 x 62.....	1,38
De 20,00 x 20,00 x 62.....	1,47
De 22,00 x 20,00 x 62.....	1,50
De 25,00 x 20,00 x 62.....	1,75
* De 26,00 x 15,00 x 62.....	1,55
De 30,00 x 20,00 x 62.....	2,03

**No Disponible**

\* Bovedillas especiales

VOLADOS	
	e/ml
Hasta 0,50.....	6,55
" 1,00.....	6,97
" 1,50.....	7,65
" 2,00.....	7,70

**No Disponible**

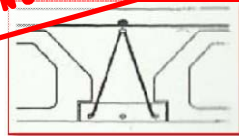

BLOQUES		
E x 25 x 50 (cm)	Hueco	Macizo
	e/Ud	e/Ud
06.....	0,86	-
09.....	0,86	-
12.....	0,92	1,40
20.....	1,25	2,24
20-R.....	1,34	-
25.....	1,40	-
25-R.....	1,62	-
Muro-25.....	1,79	-

IMBORNAL	
	e/Ud
86 x 45 (x 70 cm).....	82,41

**No Disponible**

MALLAZO	
	20 x 20 x Ø5
Precio según mercado.	

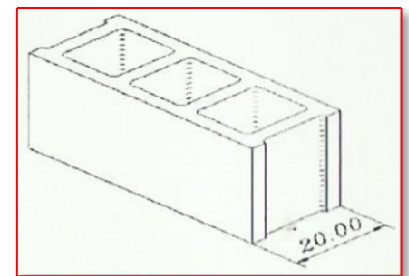
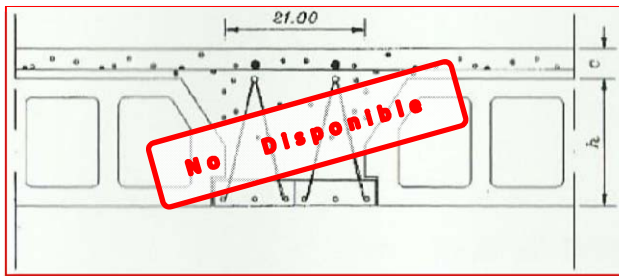
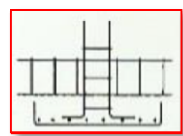

VARIOS		
	Alto x Largo x Ancho	€/Ud
Celosia gris normal.....	30 x 50 x 7,5	2,98
Ladrillo .....	25 x 12 x 06	0,60
Malecon.....	65 x 90 x 35	59,54
Caz 30 saneamiento.....	45 x 50 x 45	13,48

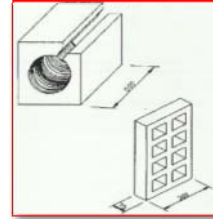

BORDILLOS		
	Alto x Largo x Ancho	€/Ud
Cedro.....	29 x 49 x 08	2,62
Mini Cedro.....	13 x 49 x 08	1,67
Hiedra.....	30 x 49 x 15	3,81
Minihiedra.....	17 x 49 x 15	2,97
Cardon.....	30 x 49 x 20	5,36
Palmera.....	50 x 50 x 50	19,53
Drago.....	45 x 49 x 45	11,43
Minidrigo.....	45 x 25 x 45	8,46
Ficus.....	25 x 49 x 20	4,65
Malaga.....	50 x 25 x 40	4,31
Mini Malaga.....	30 x 24 x 50	3,70
Orobal.....	25 x 29 x 12	1,89
Verol.....	45 x 50 x 20	7,04
Bordillo L.....	30/16 x 50 x 45	7,27
Torre flor.....	25 x 25 x 50	5,48
Tilo.....	25 x 50 x 12	5,00
Gualda.....	40 x 50 x 30	10,61
Brezo.....	20 x 50 x 20	4,28
Trébol.....	30 x 50 x 28	8,10

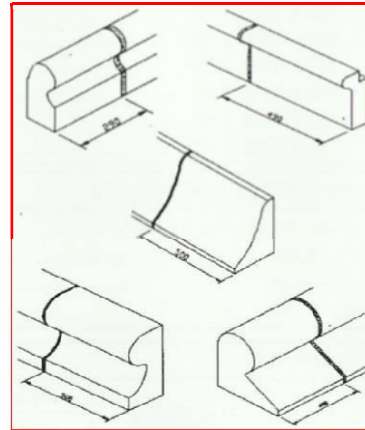

ENSACADOS	€
Cemento 25 Kg.....	Precios según mercado.
Mortero 25 Kg.....	

ARIDOS	€
Aridos, Arena	Precios según mercado.
Picón, Revuelto	

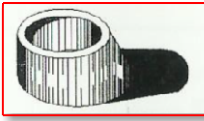

CONOS		
Características	e/Ud	
Ø Inferior 1200 mm.....	131,87	
Ø Superior 600 mm		
Altura H 850 mm		
Espesor 120 mm		

ANILLAS		
H x Ø 1200 (mm)	e/Ud	
250.....	38,82	
500.....	71,33	
1000.....	122,64	

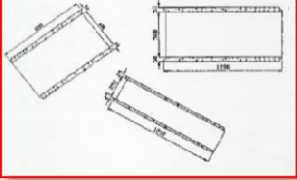
TUBOS DE HORMIGON		
Ø x L x e (mm)	e/Ud	
200 x 1000 x 40.....	4,88	
300 x 1200 x 40.....	7,14	
400 x 1200 x 40.....	12,62	
500 x 1200 x 50.....	21,56	
600 x 1200 x 60.....	28,57	
800 x 1200 x 80.....	51,80	
1000 x 1000 x 100.....	66,09	

ARQUETAS SIN FONDO		e/Ud
40 x 40 (cm) sección e x topor.	"	52,40
48 x 48	"	57,15
60 x 60	"	65,49
70 x 70	"	73,82

ARQUETAS CON FONDO		e/Ud
Tipo H (104 x 94 x 96) cm.....	"	347,87
Tipo D (135 x 115 x 104) cm.....	"	507,15

DINTELES						
	Dintel	100	130	160	200	240
	Bloque					
	9	5,23 €/ml				
	12	7,74 €/ml		10,71 €/ml		
20	9,41 €/ml		11,97 €/ml			

**FABRICA Y OFICINAS**

Autopista de Gando km 14  
 35219 TELDE (Gran Canaria)  
 Tel: 928 700 530  
 Fa x : 928 700 299

www.dopesa.com  
 e-mail: dopesa@dopesa.com